

REV.	ECN NO	DESCRIPTION	REVISED	DATE
A		New drawing	徐民建	24.01.08

JWPF-2AS

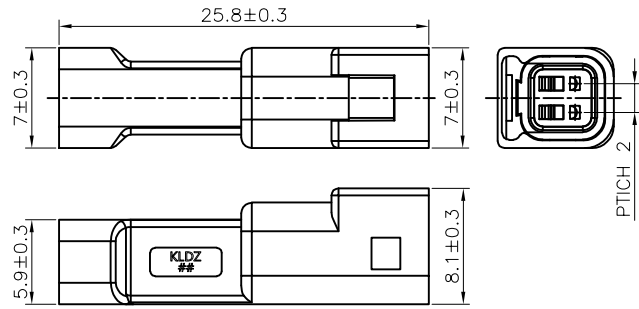

JWPF-2*3AS

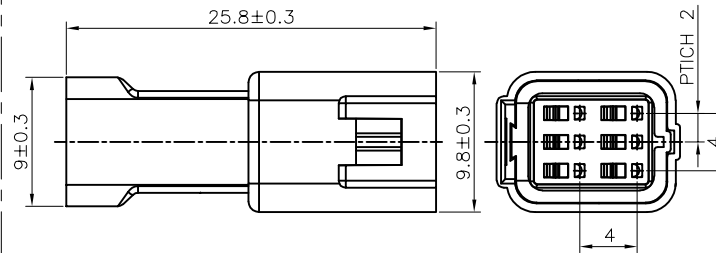

JWPF-3AS

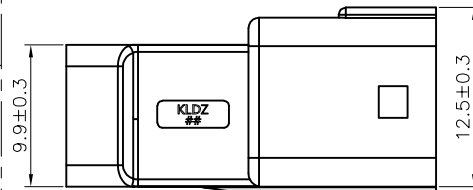
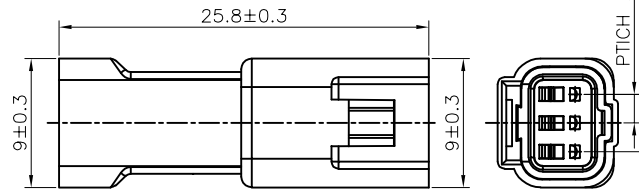

JWPF-2*4AS

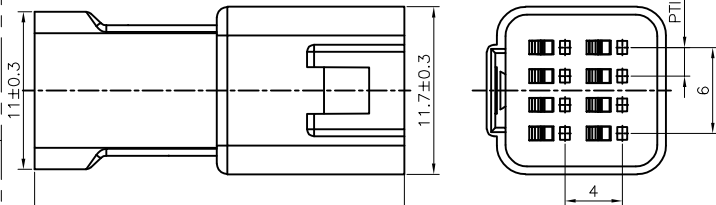

JWPF-4AS

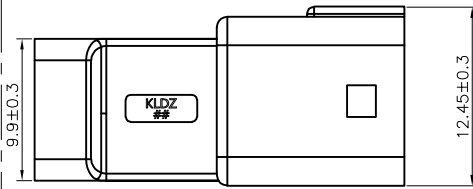
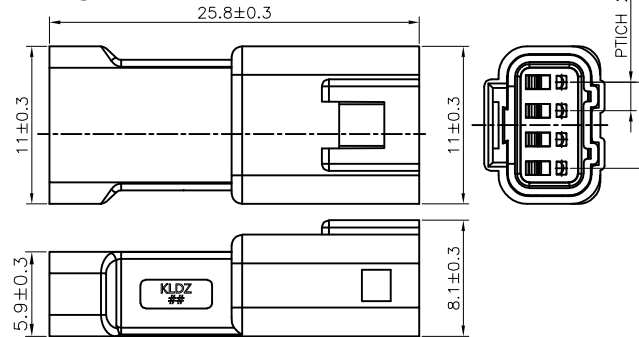

Specifications / 技术规格:

Current Rating: 3A

额定电流: 3A

Insulation Resistance: 1000MΩ Min.
绝缘电阻: 最小1000MΩ

Dielectric Withstanding: 800V AC
耐电压: 800V AC

Contact Resistance: 20mΩ Max.
接触电阻: 最大20mΩ

Operating Temperature: -25°C to +85°C
工作温度: -25°C 到 85°C

Materials / 材料:

Insulation Material: PBT UL94V-0
绝缘体塑胶材料: PBT UL94V-0

浙江快利电子有限公司
ZheJiang KuaiLi Electronic Co., LTD.

GENERAL TOLERANCE	
X. ° : ±3°	X. : --
.X ° : ±2°	X.X : ±0.30
.XX ° : ±1°	X.XX : ±0.20
.XXX ° : ±0.5°	X.XXX : ±0.10

DESIGN:	徐民建	DATE:	2024. 1. 8
CHECKED:	王子林	DATE:	2024. 1. 8
APPROVED:	朱建华	DATE:	2024. 1. 8

DWG. NO.	
PART NO.	KL-JWPF-NAS

TITLE.	JWPF-NAS
--------	----------

REV.	UNIT.	SCALE.	PAGE.	PROJ.
A	mm	-	1/1	