

REV.	ECN NO	DESCRIPTION	REVISED	DATE
A		新订图面	KEVIN	2016.4.18

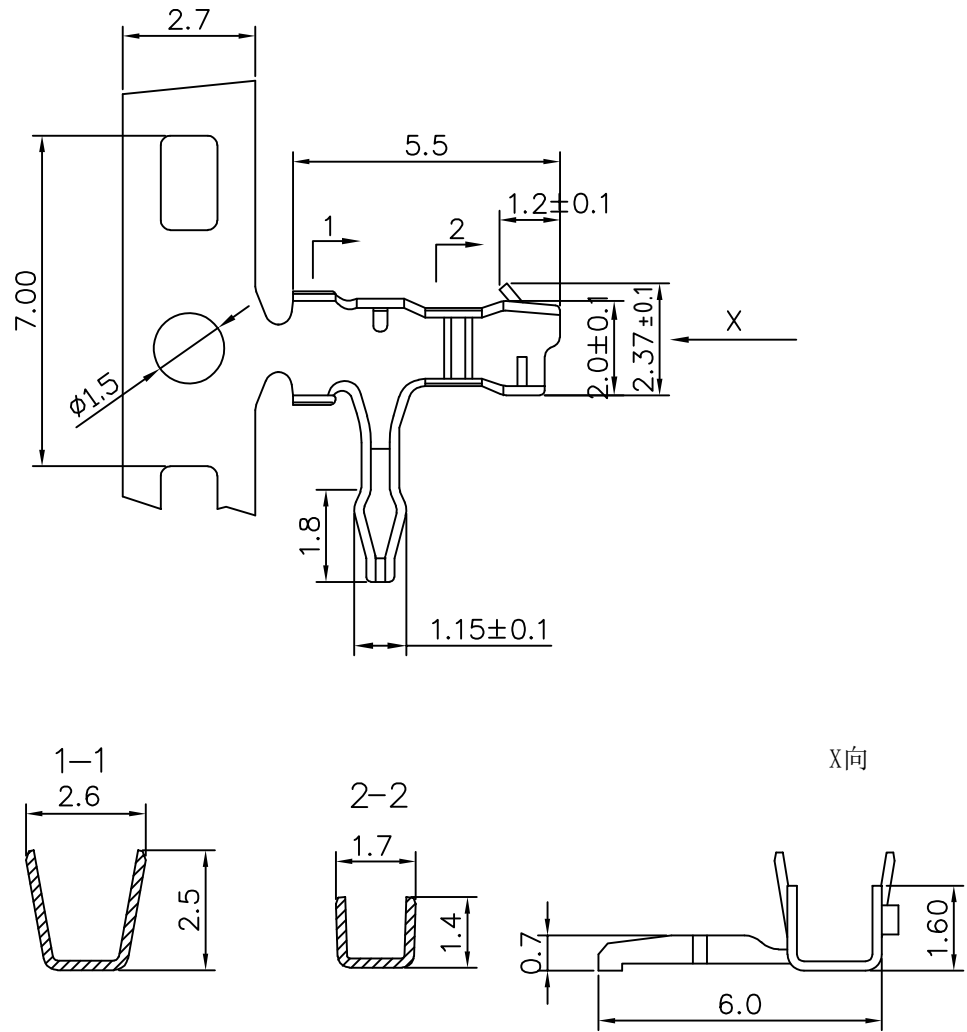

Specifications / 技术规格:

Current Rating: 3A

额定电流: 3A

Insulation Resistance: 1000MΩ Min.

绝缘电阻: 最小1000MΩ

Dielectric Withstanding: 1000V AC

耐电压: 1000V AC

Contact Resistance: 20mΩ Max.

接触电阻: 最大20mΩ

Operating Temperature: -25°C to +85°C

工作温度: -25°C 到 85°C

Materials / 材料:

Contact Material: Phosphor Bronze(Sn plating)

接触端子材料: 磷铜(镀锡)

 浙江快利电子有限公司
ZheJiang KuaiLi Electronic Co., LTD.

GENERAL TOLERANCE

X.: ±3°	X.: ±0.35
.X: ±2°	X.X: ±0.25
.XX: ±1°	X.XX: ±0.15
.XXX: ±0.5°	X.XXX: ±0.10

DESIGN: KEVIN

DATE: 2016-04-18

DWG. NO.

TITLE.

CHECKED: 李晓明

DATE: 2016-04-18

PART NO.

JC25-TE(7.0)

APPROVED: 朱建华

DATE: 2016-04-18

KL-JC25-TE-02

REV.	UNIT.	SCALE.	PAGE.	PROJ.
A	mm	-	1/1	