

REV.	ECN NO	DESCRIPTION	REVISED	DATE
A		新订图面	HELLER	2021.06.06

CKT	A	B	C
2X4	10.30	4.50	7.25
2X5	11.80	6.00	8.75
2X6	13.30	7.50	10.25
2X7	14.80	9.00	11.75
2X8	16.30	10.50	13.25
2X9	17.80	12.00	14.75
2X10	19.30	13.50	16.25
2X11	20.80	15.00	17.75
2X12	22.30	16.50	19.25
2X13	23.80	18.00	20.75
2X14	25.30	19.50	22.25
2X15	26.80	21.00	23.75
2X16	28.30	22.50	25.25
2X17	29.80	24.00	26.75

Specifications / 技术规格:

Current Rating: 1A
额定电流: 1A

Voltage rating: 100V AC,DC
额定电压: 100V AC,DC

Insulation Resistance: 500M ΩMin.
绝缘电阻: 最小500MΩ

Dielectric Withstanding: 500V AC
耐电压: 500V AC

Operating Temperature: -25°C to +85°C
工作温度: -25°C 到 85°C

Materials / 材料:

Insulation Material: Nylon/PBT UL94V-0
绝缘体塑胶材料: 尼龙/PBT UL94V-0

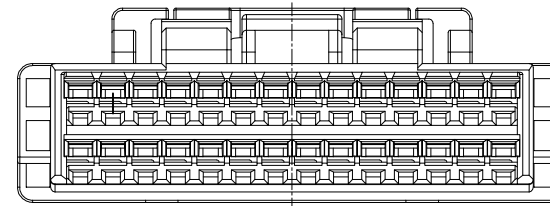
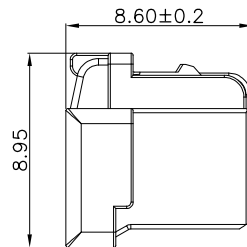
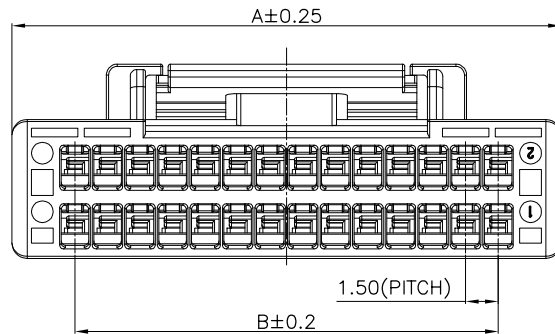
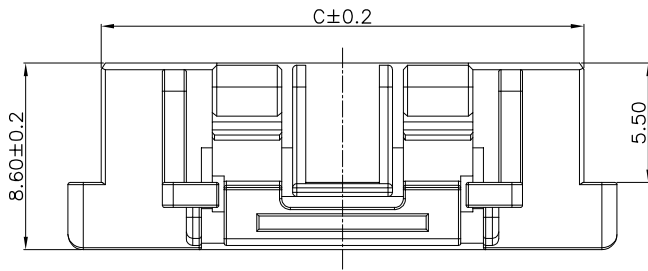

 浙江快利电子有限公司
ZheJiang KuaiLi Electronic Co., LTD.

GENERAL TOLERANCE

X.: ± 3'	X.: --
.X: ± 2'	X.X: ±0.20
.XX: ± 1'	X.XX: ±0.20
.XXX: ± 0.5'	X.XXX: --

DESIGN: HELLER

DATE: 2021-06-06

DWG. NO.

TITLE.

CHECKED:

DATE:

PART NO.

1502-2XNY

APPROVED:

DATE:

KL-1502-2XNY

REV.	UNIT.	SCALE.	PROJ.
A	mm	-	

REV.	ECN NO	DESCRIPTION	REVISED	DATE
A		新订图面	HELLER	2021.06.06

PRODUCT SHAPE AT EACH CKT

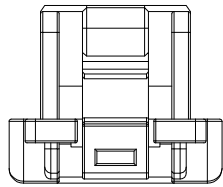

FIGURE OF 8 CIRCUITS (1 LOCK)

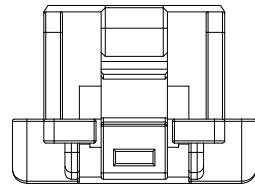

FIGURE OF 10 CIRCUITS (1 LOCK)

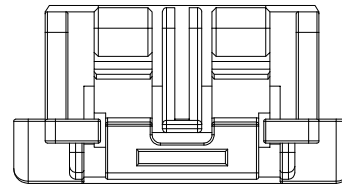

FIGURE OF 12-18 CIRCUITS (2 LOCKS)

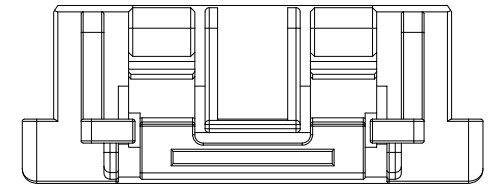
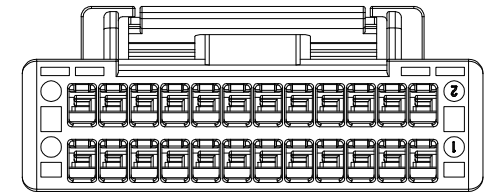
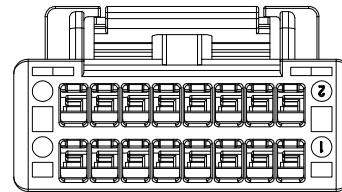
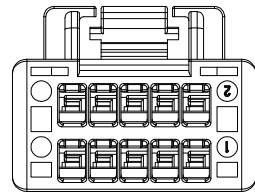
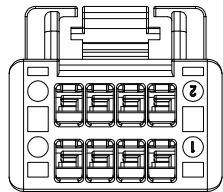

FIGURE OF 20-34 CIRCUITS (2 LOCKS)



 浙江快利电子有限公司
ZheJiang KuaiLi Electronic Co., LTD.

GENERAL TOLERANCE	
X.: ± 3'	X.: ± 0.35
.X: ± 2'	X.X: ± 0.25
.XX: ± 1'	X.XX: ± 0.15
.XXX: ± 0.5'	X.XXX: ± 0.10

DESIGN:	HELLER	DATE:	2021-06-06
CHECKED:		DATE:	
APPROVED:		DATE:	

DWG. NO.	
PART NO.	KL-1502-2XNY

TITLE.	1502-2XNY
--------	-----------

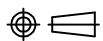
REV.	A	UNIT.	mm	SCALE.	-	PROJ.	
------	---	-------	----	--------	---	-------	---